



LA1265

FM/AM Tuner of Electronic Tuning Type

Functions

FM : IF amplifier, quadrature detector, AF preamplifier, signal meter, tuning indicator drive output (common with stop signal, muting drive output).

AM : RF amplifier, MIX, OSC (with ALC), IF amplifier, detector, AGC, signal meter, tuning indicator drive output (common with stop signal).

Features

- Minimum number of external parts required.
- Excellent S/N.
- Local OSC with ALC.
- Local OSC buffer.
- Tuning indicator pin (common with narrow-band stop signal and muting drive output).
- Variable stop sensitivity (variable separately for FM, AM)
- Low whistle.
- Signal meter pin.

Package Dimensions

unit : mm

3059-DIP22S

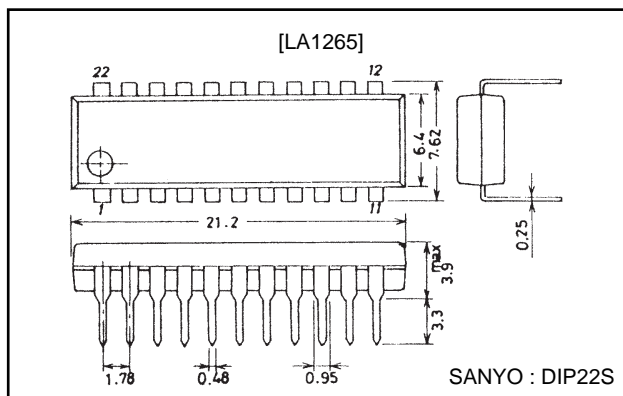

Specifications

Maximum Ratings at Ta=25°C, See specified Test Circuit.

Parameter	Symbol	Conditions	Ratings	Unit
Maximum supply voltage	V _{CC} max	Pins 7, 8, 17	16	V
Flow-in current	I ₈	Pin 8	20	mA
Flow-out current	I ₂₀	Pin 20	1	mA
	I ₂₂	Pin 22	2	mA
Allowable power dissipation	P _d max	T _a ≤ 60°C	650	mW
Operating temperature	T _{opr}		-20 to +70	°C
Storage temperature	T _{stg}		-40 to +125	°C

Operating Conditions at Ta=25°C

Parameter	Symbol	Conditions	Ratings	Unit
Recommended operating voltage	V _{CC}		8.5	V
Operating voltage range	V _{CC} op		6 to 14	V

LA1265

Operating Characteristics at $T_a=25^\circ\text{C}$, $V_{CC}=8.5\text{V}$, See specified Test Circuit

Parameter	Symbol	Conditions	Ratings			Unit
			min	typ	max	
[AM : $f=1\text{MHz}$]						
Quiescent current	Icco	No input		18	26	mA
Detection output	V _{O1}	V _{IN} =20dB μ , 400Hz, 30% mod.	30	50	90	mV
	V _{O2}	V _{IN} =80dB μ , 400Hz, 30% mod.	110	160	220	mV
S/N	S/N1	V _{IN} =20dB μ	16	20		dB
	S/N2	V _{IN} =80dB μ	49	54		dB
Total harmonic distortion	THD1	V _{IN} =80dB μ , 400Hz, 30% mod.		0.3	1.0	%
	THD2	V _{IN} =107dB μ , 400Hz, 30% mod.		0.5	2.0	%
Signal meter output	V _{SM 1}	No input	0	0	0.2	V
	V _{SM 2}	V _{IN} =80dB μ	2.4	2.8	3.1	V
LED lighting sensitivity	VLED on	I _{LED} =1mA	15	24	33	dB μ
Local OSC buffer output	V _{OSC}	f _{OSC} =1.45MHz	220	275	330	mV
[FM : $f=10.7\text{MHz}$]						
Quiescent current	Icco	No input		20	28	mA
Input limiting sensitivity	-3dBLS.	3dB down, 400Hz, 100% mod.		31	37	dB μ
Demodulation output	V _O	V _{IN} =10dB μ , 400Hz, 100% mod.	240	330	460	mV
S/N	S/N	V _{IN} =100dB μ	78	84		dB
Total harmonic distortion	THD	V _{IN} =100%dB μ , 400Hz, 100% mod.		0.03	0.3	%
Signal meter output	V _{SM 1}	No input	0	0	0.2	V
	V _{SM 2}	V _{IN} =100dB μ	1.5	2.7	3.1	V
LED lighting sensitivity	LED-on	I _{LED} =1mA	35	50	65	dB μ
LED lighting bandwidth	LED-BW	V _{IN} =100dB, I _{LED} =1mA	90	120	160	kHz
AM rejection ratio	AMR	V _{IN} =100dB μ , FM=400Hz 100% mod. AM=1kHz 30% mod.	45	60		dB

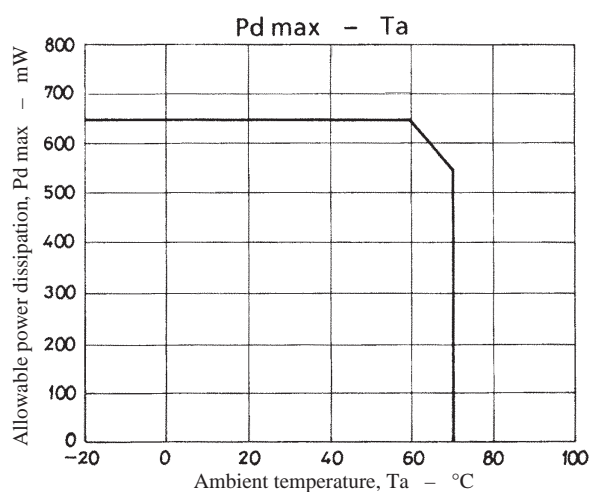

Equivalent Circuit Block Diagram

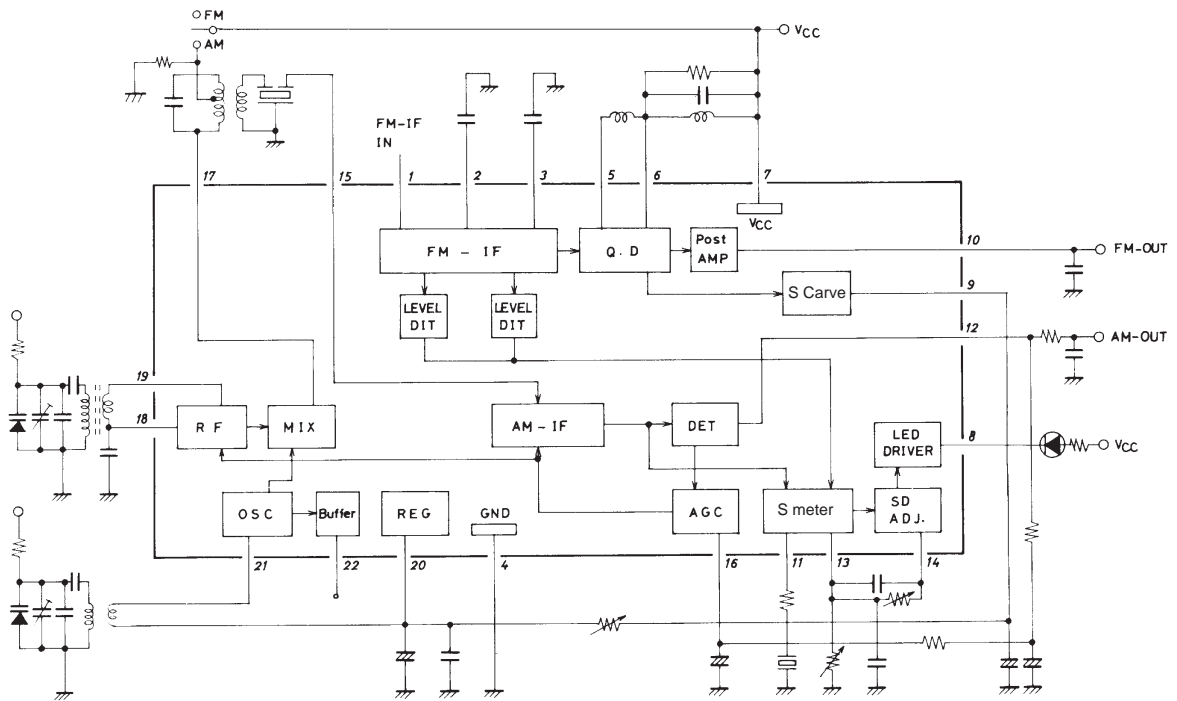

How to use the LA1265

1. LED lighting, muting drive output, stop signal (SD).

- For LED lighting, muting drive output, stop signal, the output at pin 8 is used.
- The voltage on pin 8, when tuned, turns from "H" to "L". (Active-Low)
- Signal bandwidth at pin 8.
 - For AM, the bandwidth depends on the CF (BFU450CN) at pin 11. If a capacitor is connected in place of the CF, the bandwidth will get wider.
 - For FM, the bandwidth depends on the resistance across pins 9 and 20. If the resistance is increased, the bandwidth will get narrower. $R=15k\Omega$ makes the bandwidth approximately 120kHz.

LED Lighting Bandwidth – Resistance across pins 9 and 20

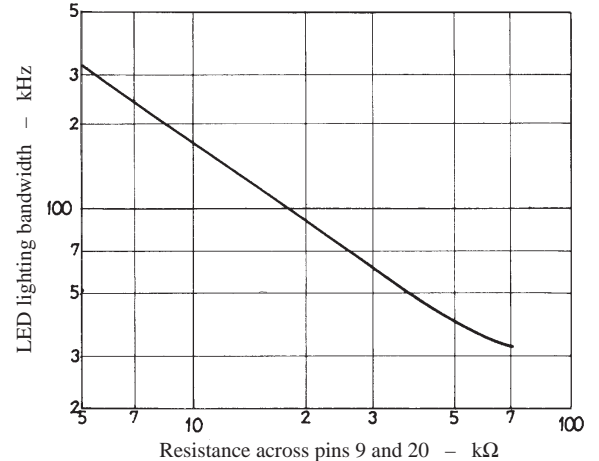

- Sensitivity adjustment of LED, muting, stop signal.
 - For FM, the semifixed variable resistor across pin 13 and GND is used.
 - For AM, the semifixed variable resistor across pins 13 and 14 is used. Be sure to start adjustment for FM, and then make adjustment for AM. For the stop signal sensitivity and FM stop signal bandwidth, the variations should be considered and it is recommended to use the semifixed variable resistor for adjustment.
- LED lighting sensitivity setting for AM.

For the LED lighting sensitivity setting for AM, it is desirable that the IC input be $30dB\mu$ (antenna input : approximately $50dB/m$). In this case, the value of VR1 is $30k\Omega$.

- LED lighting sensitivity setting for FM.
 - For the LED lighting sensitivity setting for FM, the IC input may be 45dBμ to 60dBμ. With the variations in the front end considered, it is ideal that the IC input in a standard receiving set be 51dBμ to 54dBμ. The lower value of VR2 for the LED lighting sensitivity setting is as illustrated right. Since the variations in the front end cause the IC input setting sensitivity to vary, it is recommended to use a value of VR2 at an input voltage lower than a standard setting by 6dB or greater. For example, if IC input 53dBμ is taken as a standard, use VR2≤100kΩ at IC input 47dBμ.

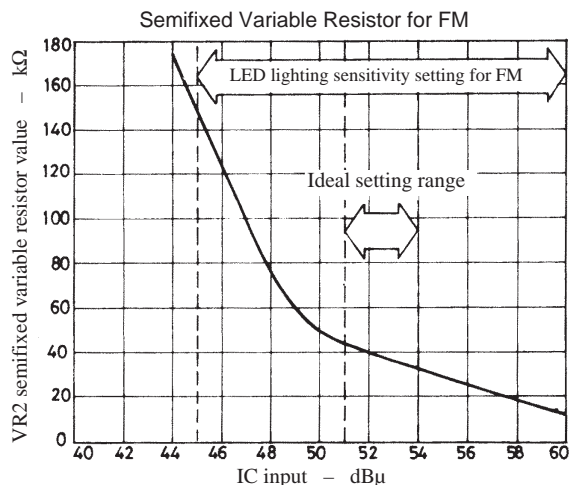

2. AM/FM changeover

- Two selections are available for changeover as shown below : (A) pin 17-used method and (B) pin 18-used method.
- For (A), the voltage on pin 17 relative to VCC (pin 7) must be within the range of -0.8V to +0.1V. If not within this range, distortion and selectivity will get worse.
- For (A), a resistance of 68kΩ at the IFT cold terminal, which is used to prevent the changeover circuit from malfunctioning, must be connected.

(A) pin 17-use method for AM/FM changeover

(B) Pin 18-used method for AM/FM changeover

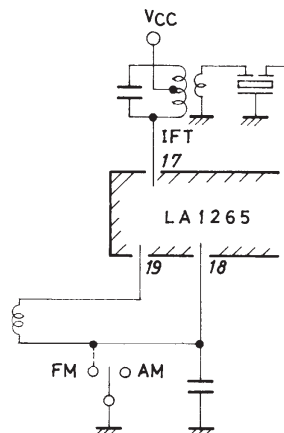
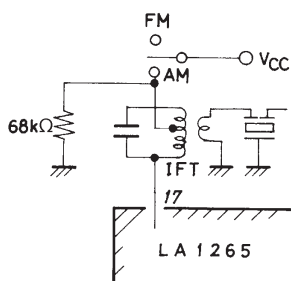

3. Local OSC buffer output

- When local OSC buffer output wave form is saw-toothed at the SW mode, connect a resistance of 1.2kΩ or thereabouts across pin 22 and GND.

4. AM input pin

- It is desirable that the AM input pin (pin 19) be L-coupled to pin 18.
- Inputting to pin 19 can be done by DC-cutting with a capacitor. However, an unbalance in the RF amplifier (differential amplifier) causes gain drop and whistle worsening.

5. Capacitance across pin 9 and GND.

A large capacitance across pin 9 and GND may cause a misstop at an adjacent channel when the channel select speed is made faster at the automatic channel select mode. In this case, decrease the capacitance across pin 9 and GND. However, if too decreased, the LED will flutter at low modulation frequencies at the time of detuning. Therefore, it is recommended to fix the capacitance across pin 9 and GND to be 3.3μF to 10μF. The relation between modulation frequency and demodulation output voltage on pin 9 with the capacitance across pin 9 and GND as a parameter is shown right.

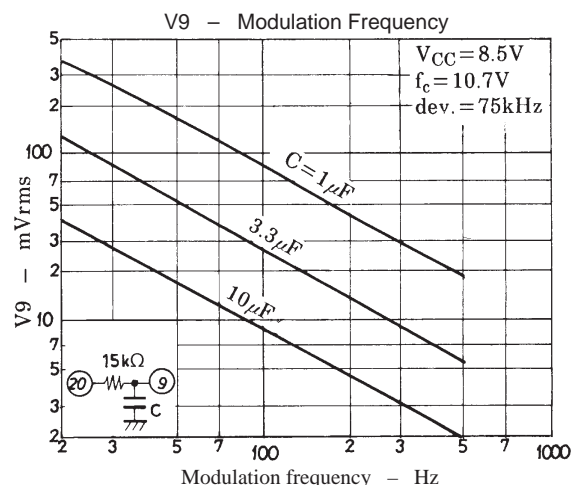

LA1265

6. If the coupling coefficient of the local OSC coil is small and an antiresonance point of approximately 100MHz is present or the stray capacitance across pins 22 and 21 is large, a parasitic oscillation of approximately 100MHz may occur in the buffer output (pin 22). In this case, connect a capacitance of approximately 30pF across pin 22 and GND.

7. AM OSC coil

Generally speaking, the following should be noted. Avoid winding with loose coupling between primary side and secondary side (especially SW1, SW2). To put it concretely, the pot core type is better than the screw core type which is loose in coupling. This prevents the local OSC frequency from turning third resonance frequency related to the coupling coefficient.

8. Resistance across pin 8 and V_{DD}.

If pin 8 is used for the stop signal (SD) only, without using LED, it is recommended to fix resistance R_L across pin 8 and GND to be 51kΩ to 100kΩ.

9. To prevent whistle from worsening, make the pattern of AM output pin 12 as short as possible.

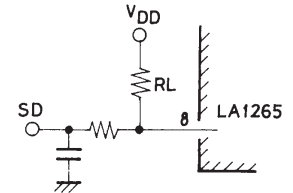

Input/Output Admittance

FM

—	Parameter	Frequency	—	Admittance	Unit
IF	γ _{i1}	10.7MHz	r _i	330	Ω
			c _i	20	pF

AM

—	Parameter	Frequency	—	Admittance		Unit
				AGC-off (V16=1.4V)	AGC-on (V16=2.5V)	
RF	γ _{i19}	1MHz	r _i	15	16	kΩ
			c _i	4	4	pF
MIX	γ _{o17}	500kHz	r _o	—	—	kΩ
			c _o	3	3	pF
IF	γ _{i15}	500kHz	r _i	2	2	kΩ
			c _o	10	8	pF

Test Circuit : FM, AM-MW

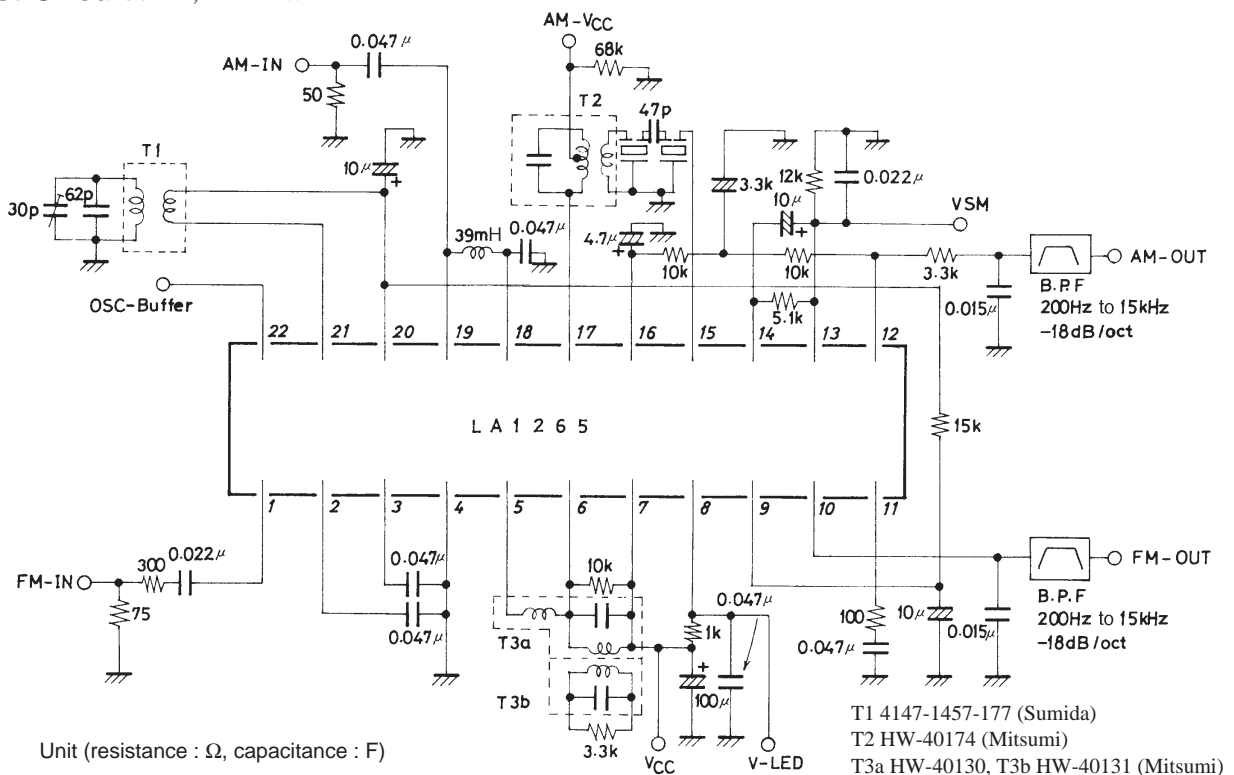

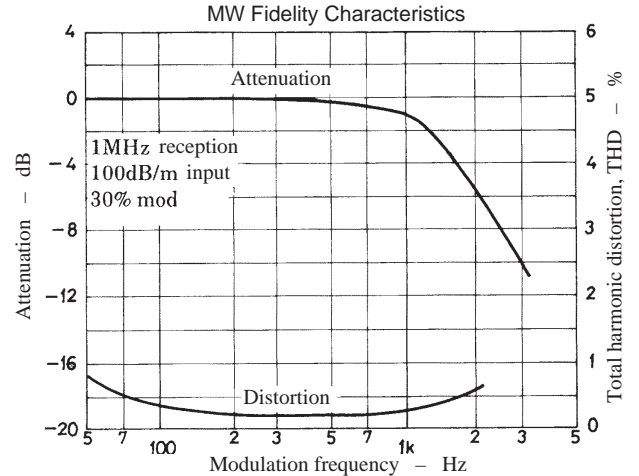
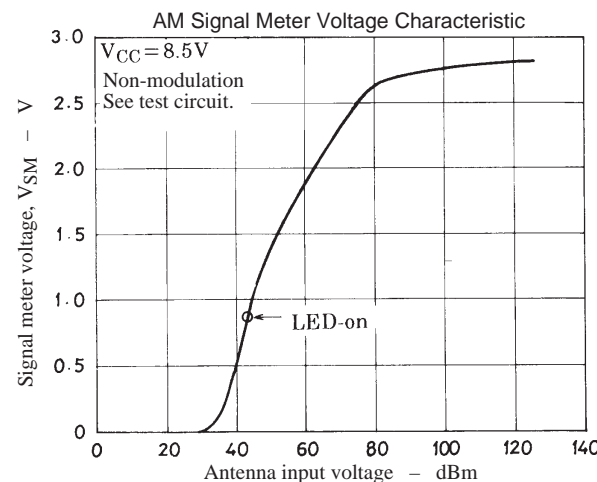
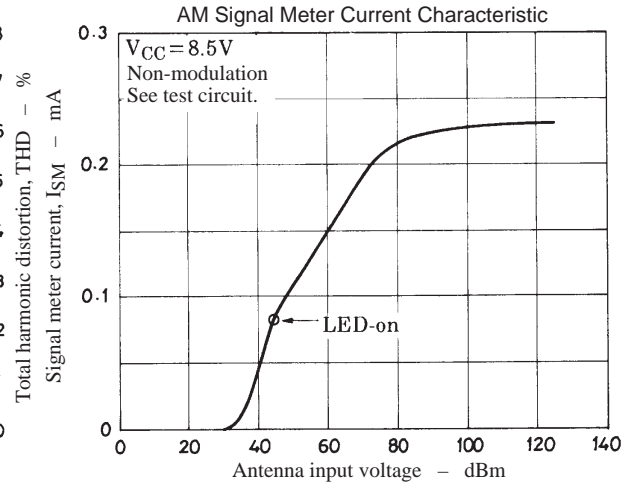
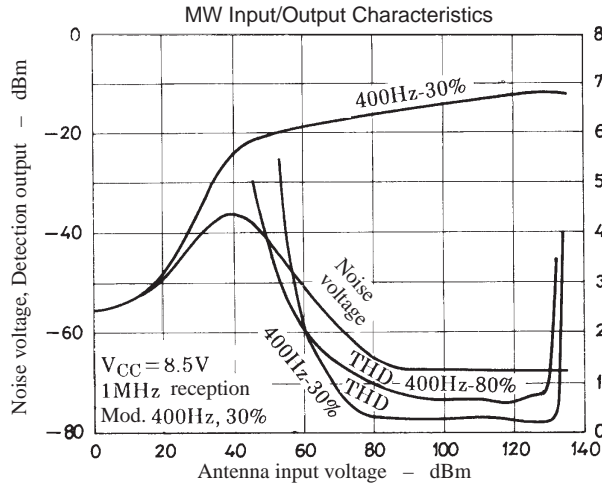
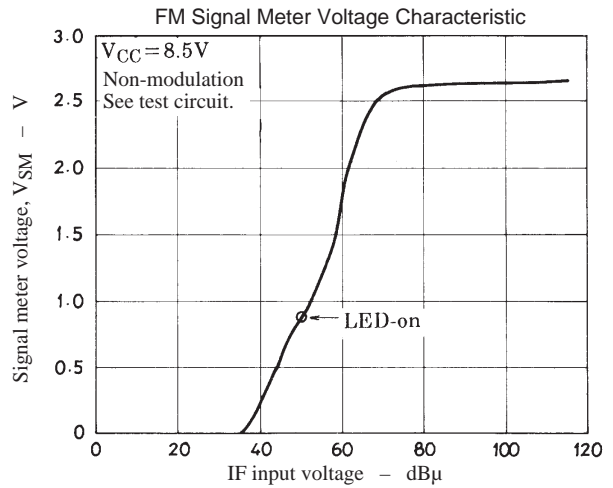
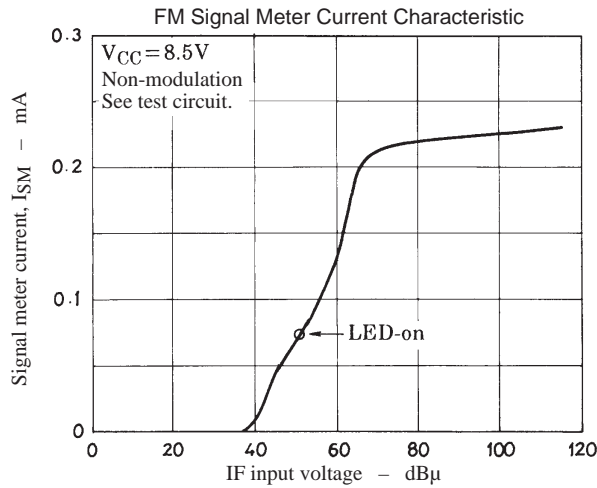
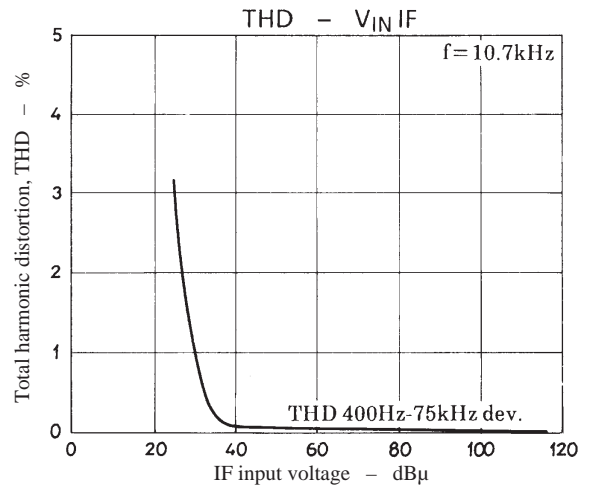
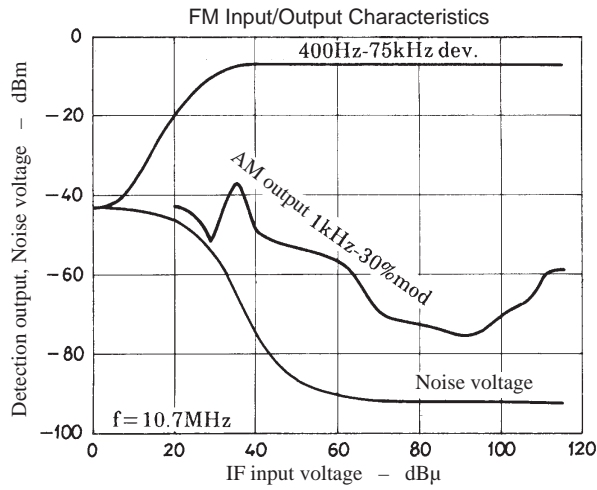

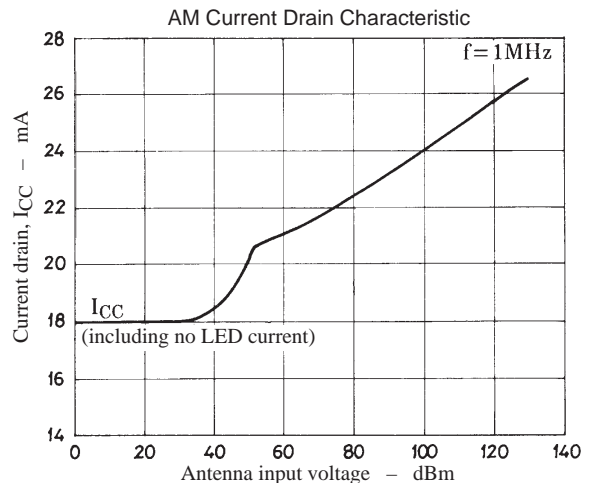
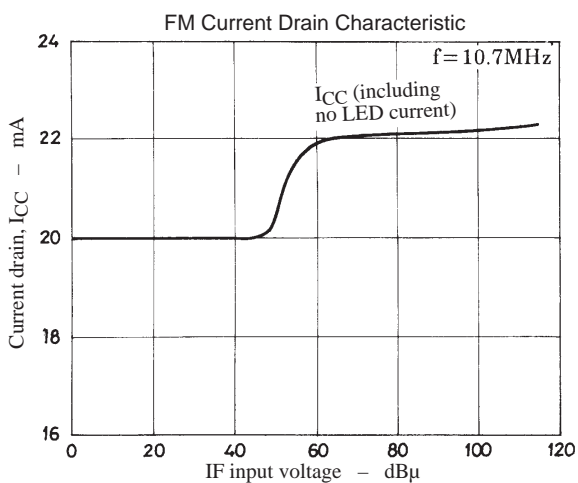
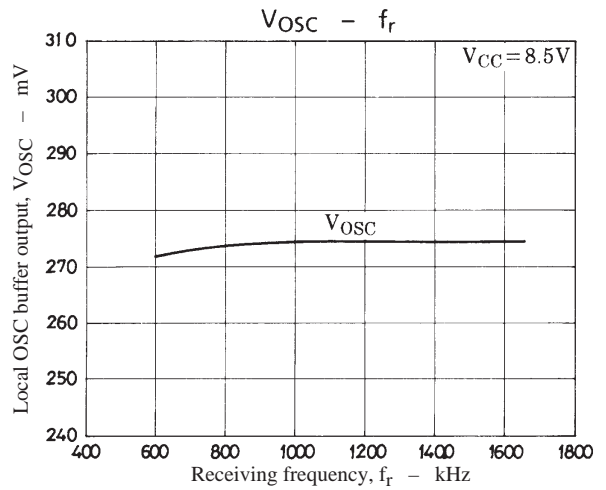
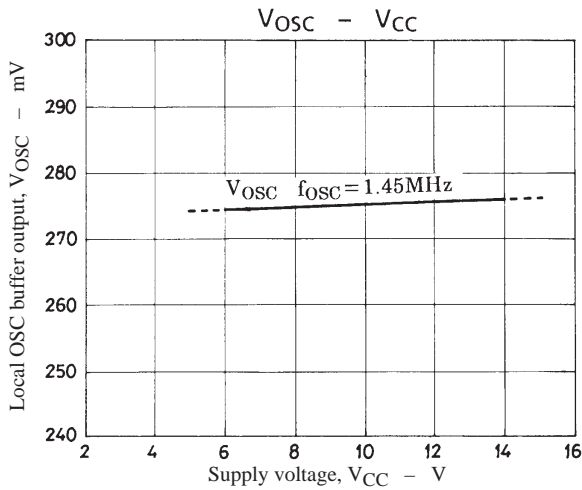
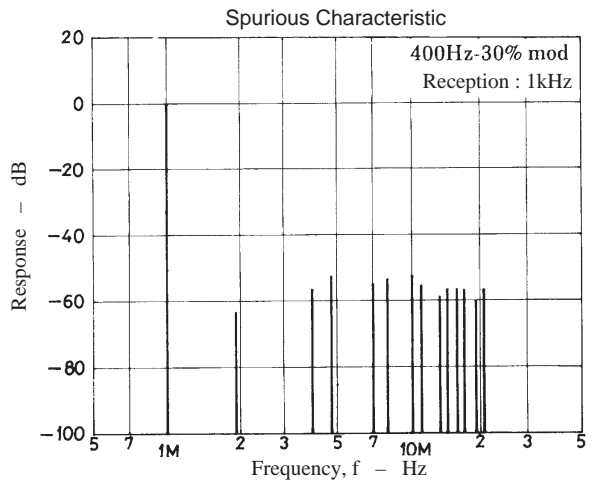
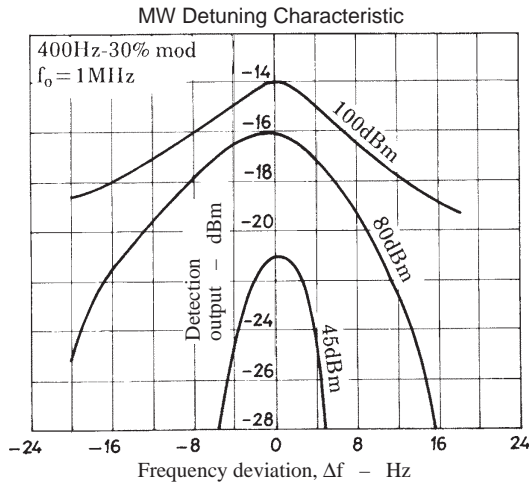
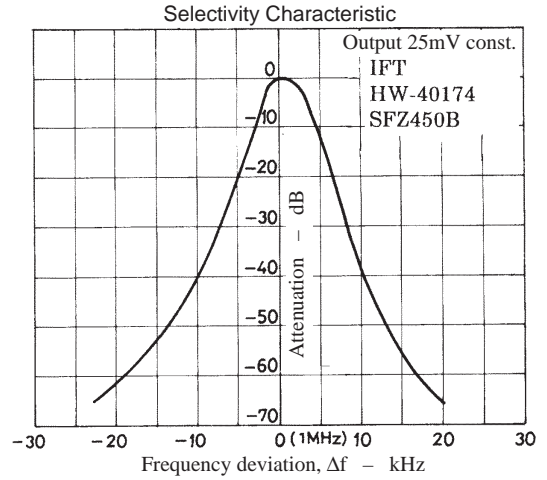
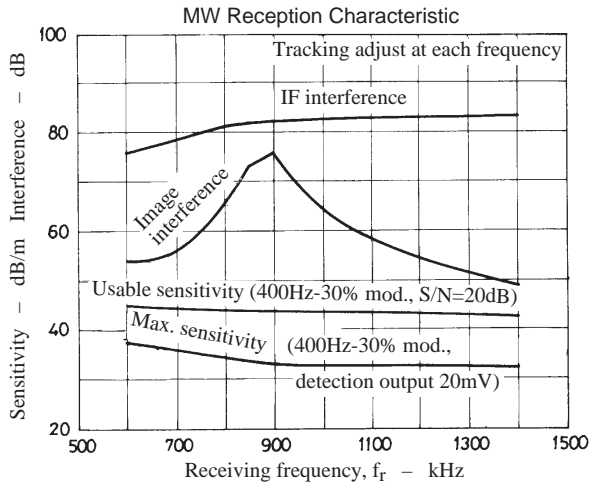

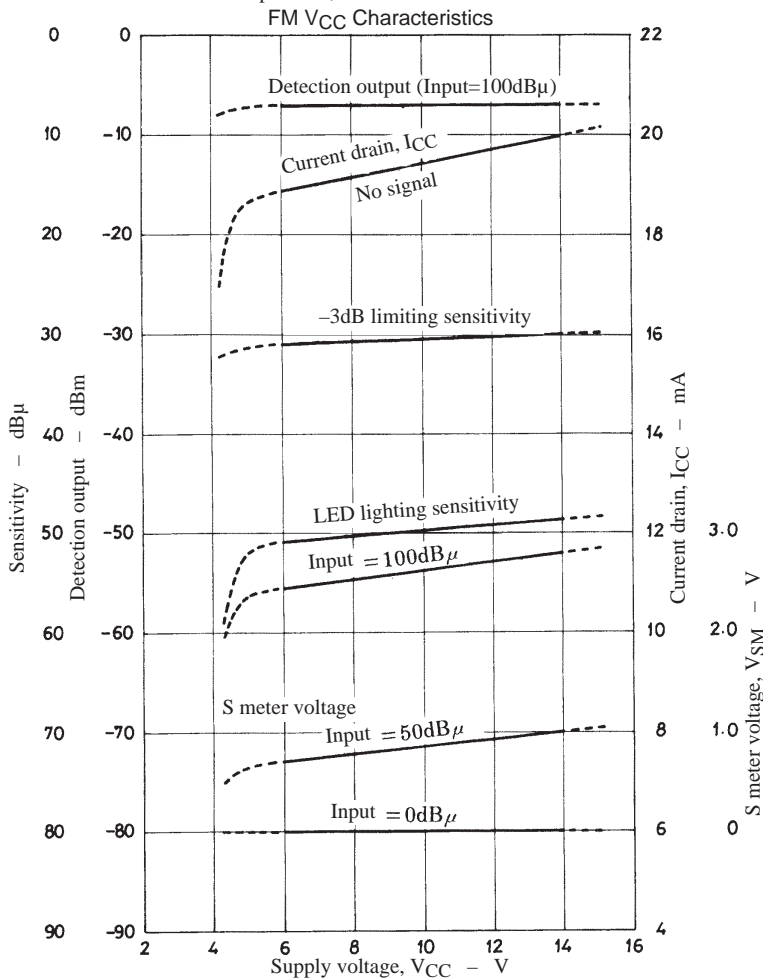
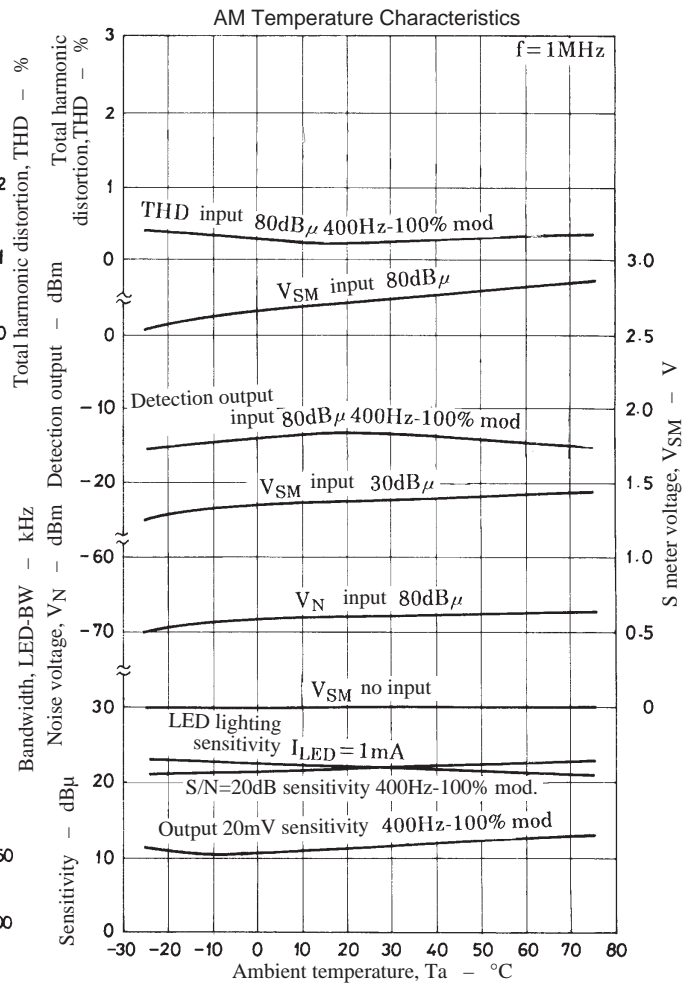
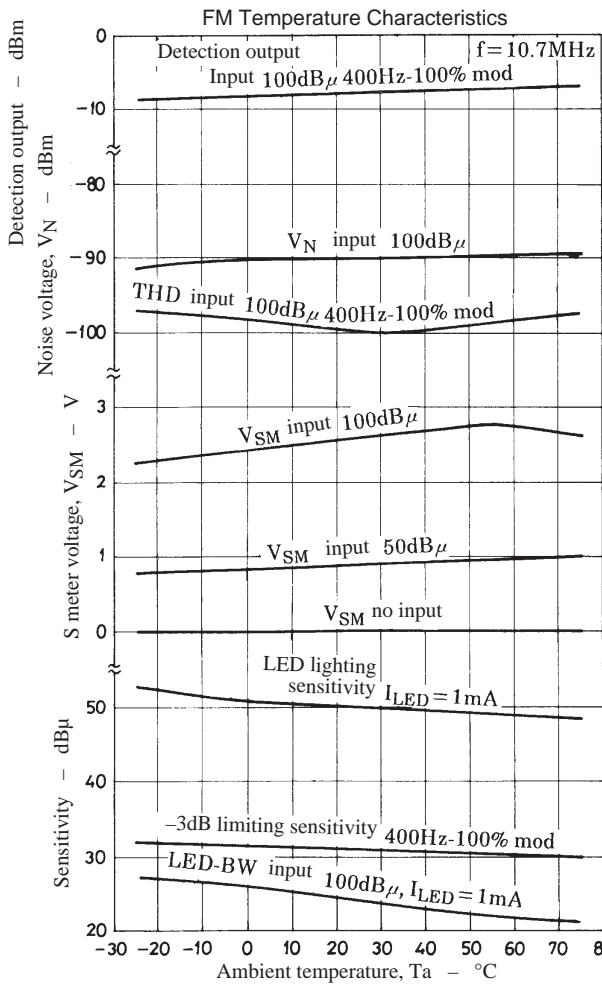

LA1265

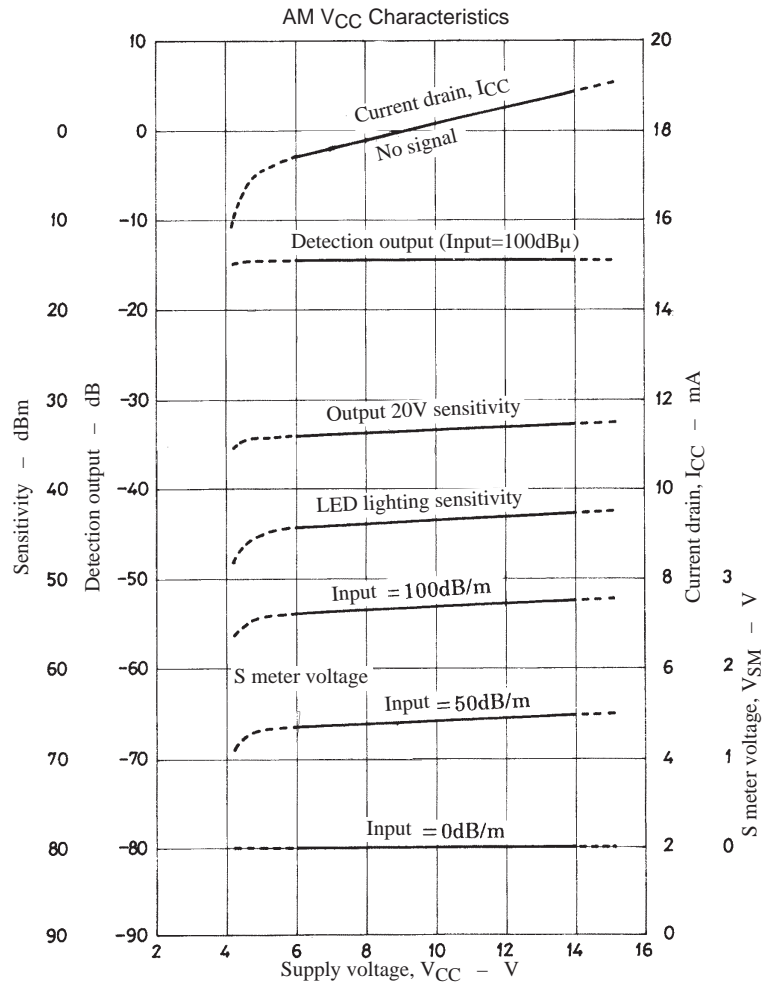

Test Circuit : SW2

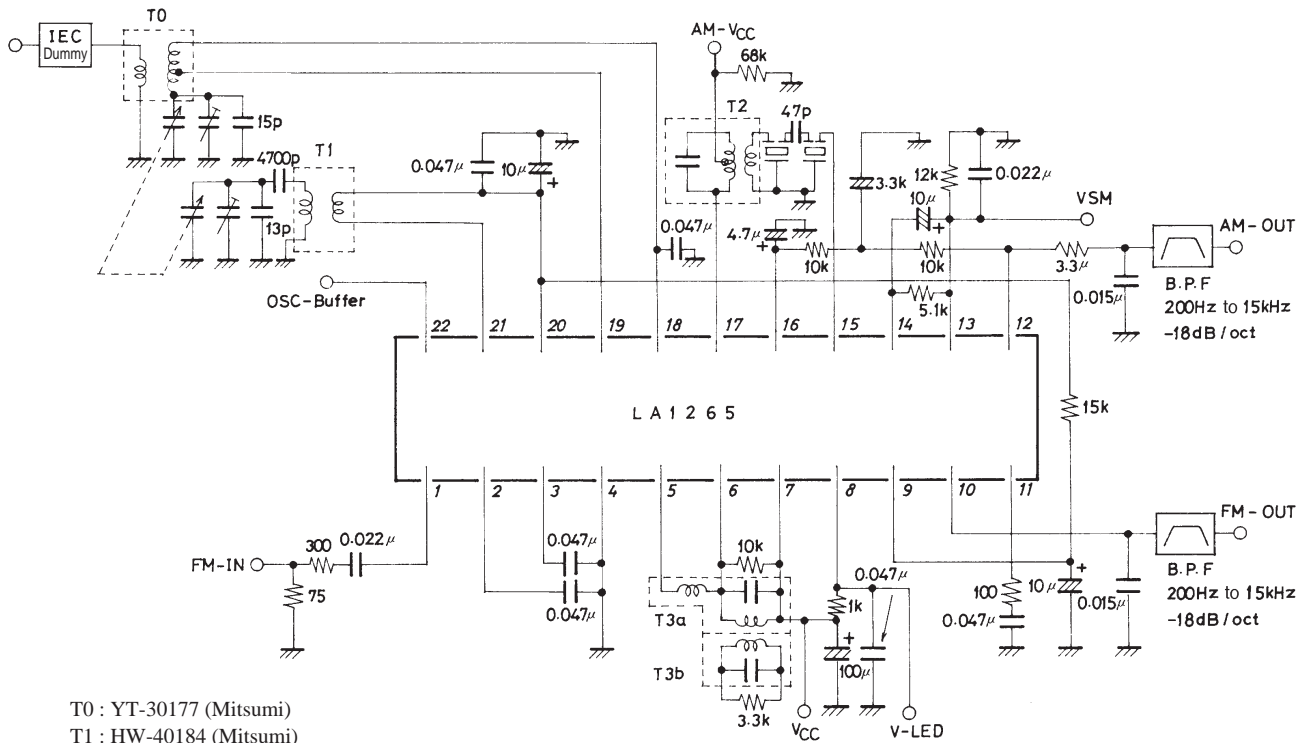

- T0 : YT-30177 (Mitsumi)
- T1 : HW-40184 (Mitsumi)
- T2 : HW-40174 (Mitsumi)
- T3a : HW-40130, T3b : HW-40131 (Mitsumi)
- Variable capacitor PVC 22KTL (Mitsumi)

Unit (resistance : Ω, capacitance : F)

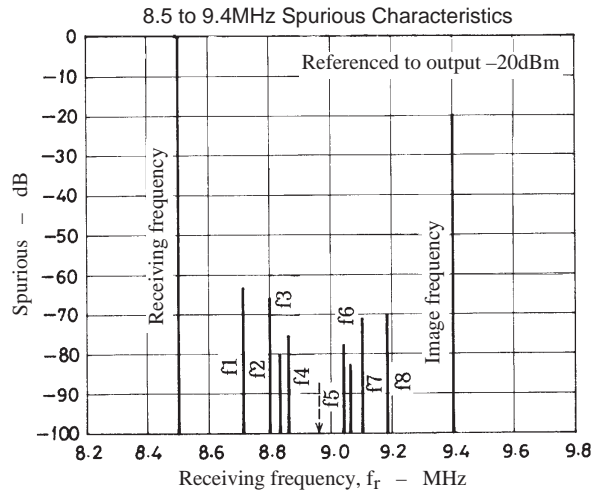
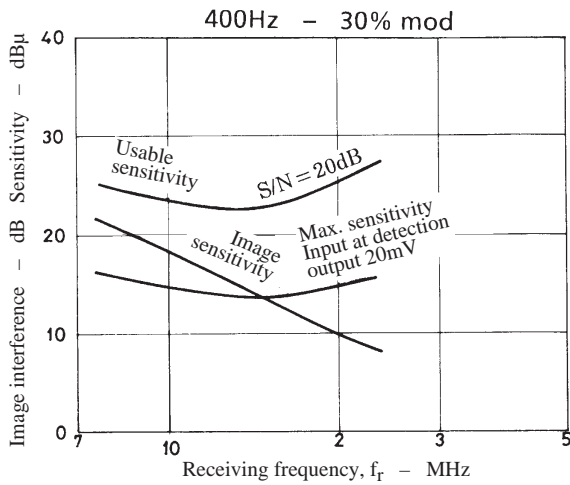
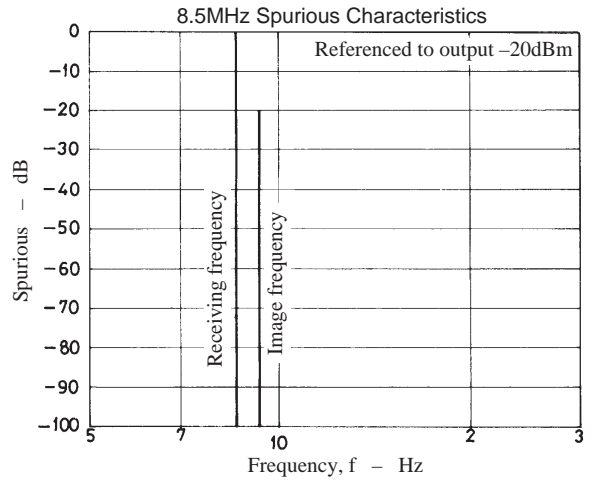
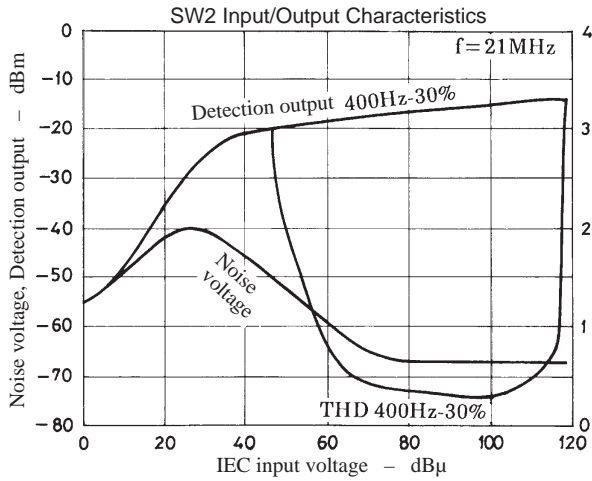
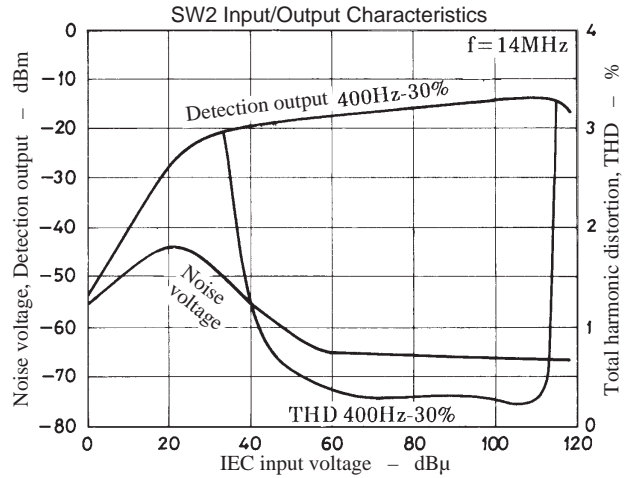
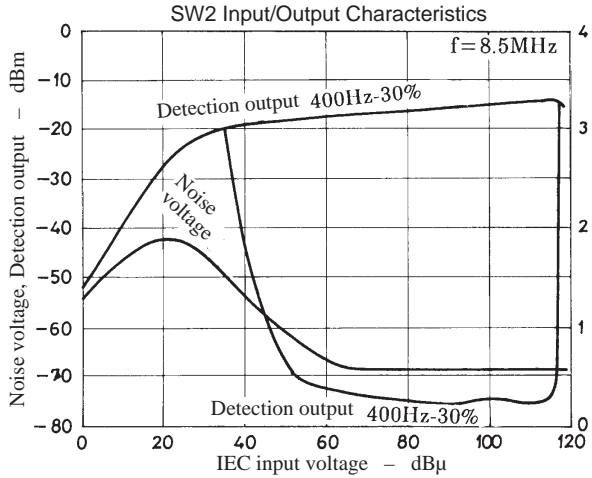

- f1 : 8.724MHz $\rightarrow 2f_{OSC} - 2f_1 = 455\text{kHz}$
- f2 : 8.799MHz $\rightarrow 3f_{OSC} - 3f_2 = 455\text{kHz}$
- f3 : 8.836MHz $\rightarrow 4f_{OSC} - 4f_3 = 455\text{kHz}$
- f4 : 8.859MHz $\rightarrow 5f_{OSC} - 5f_4 = 455\text{kHz}$
- f5 : 9.038MHz $\rightarrow 5f_5 - 5f_{OSC} = 455\text{kHz}$
- f6 : 9.061MHz $\rightarrow 4f_6 - 4f_{OSC} = 455\text{kHz}$
- f7 : 9.098MHz $\rightarrow 3f_7 - 3f_{OSC} = 455\text{kHz}$
- f8 : 9.173MHz $\rightarrow 2f_8 - 2f_{OSC} = 455\text{kHz}$

Coil Specifications

MW antenna

Bar antenna (for PVC22KTL)

- TN-10896 (Mitsumi)

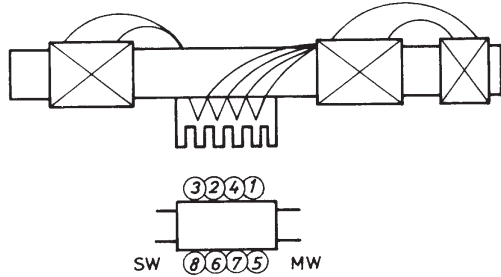

- ①-② 22T + 49T, ③-④ 10T
Tight solenoid direct winding
- ⑤-⑥ 17T 0.5φ space winding
- ⑦-⑧ 4T tight solenoid winding
- ①-② $L = 260\mu\text{H}$, $Q_0 = 330 (\geq 200)$
- ⑤-⑥ $L = 15\mu\text{H}$, $Q_0 = 250 (\geq 150)$

Loop antenna (for SVC321)

- LA300 (Korin Giken)

Loop antenna matching coil

- KT-412

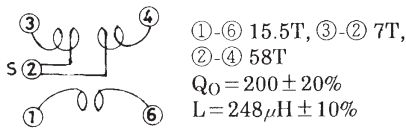

- ①-⑥ 15.5T, ③-② 7T,
- ②-④ 58T
- $Q_0 = 200 \pm 20\%$
- $L = 248\mu\text{H} \pm 10\%$

MW OSC

- 4147-1457-177 (Sumida)

For PVC22KTL

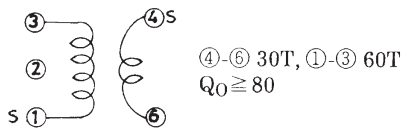

- ④-⑥ 30T, ①-③ 60T
- $Q_0 \geq 80$

- KO-387 (Korin Giken)

For SVC321

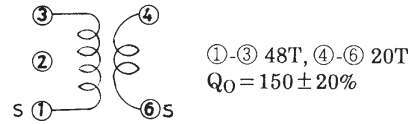

- ①-③ 48T, ④-⑥ 20T
- $Q_0 = 150 \pm 20\%$

AM-IFT

Matching coil for SFU450B (1-element type)

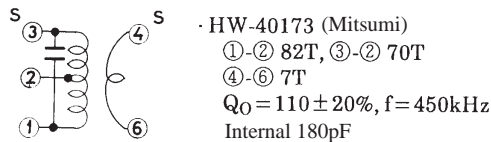

- HW-40173 (Mitsumi)
- ①-② 82T, ③-② 70T
- ④-⑥ 7T
- $Q_0 = 110 \pm 20\%$, $f = 450\text{kHz}$
- Internal 180pF

- 2150-2162-197 (Sumida)
- ①-② 103T, ③-② 71T,
- ④-⑥ 8T
- $Q_0 \geq 80$, $f = 450\text{kHz}$
- Internal 180pF

Matching coil for SFZ450B (2-element type)

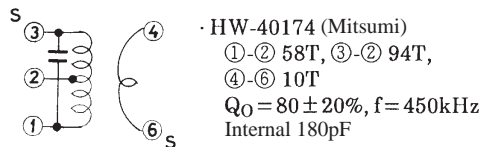

- HW-40174 (Mitsumi)
- ①-② 58T, ③-② 94T,
- ④-⑥ 10T
- $Q_0 = 80 \pm 20\%$, $f = 450\text{kHz}$
- Internal 180pF

- 2150-2061-049 (Sumida)
- ①-② 54T, ③-② 120T,
- ④-⑥ 12T
- $Q_0 \geq 40$
- Internal 180pF

FM single tuning detection coil

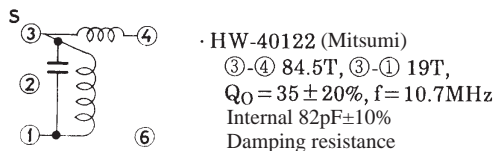

- HW-40122 (Mitsumi)
- ③-④ 84.5T, ③-① 19T,
- $Q_0 = 35 \pm 20\%$, $f = 10.7\text{MHz}$
- Internal 82pF±10%
- Damping resistance

- 2231-016 (Sumida)
- ③-④ 73.5T, ③-① 19T,
- $Q_0 = 30 \pm 20\%$, $f = 10.7\text{MHz}$
- Internal 82pF±10%
- Damping resistance

FM double tuning detection coil

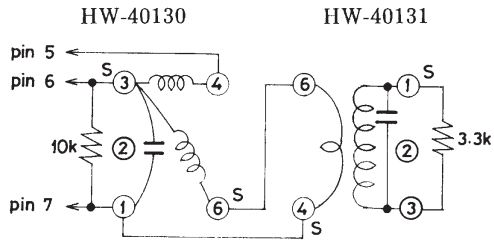

· HW-40130 (Mitsumi)
 ③-④ 86.5T
 ③-⑥ 13.5T
 $Q_0 = 50 \pm 20\%$
 Internal 100pF $\pm 10\%$

· HW-40131 (Mitsumi)
 ④-⑥ 1T
 ①-③ 19T
 $Q_0 = 35 \pm 20\%$
 Internal 100pF $\pm 10\%$

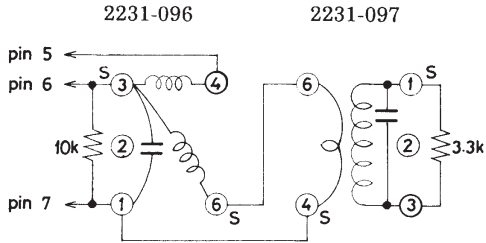

· 2231-096 (Sumida)
 ③-④ 73.5T
 ③-⑥ 23.5T
 $Q_0 = 50 \pm 20\%$
 Internal 62pF $\pm 10\%$

· 2231-097 (Sumida)
 ④-⑥ 2T
 ①-③ 21T
 $Q_0 = 47 \pm 20\%$
 Internal 82pF $\pm 10\%$

Unit (resistance : Ω)

LA1265

Sample Application Circuit : LA1186N + LA1265 (US Band)

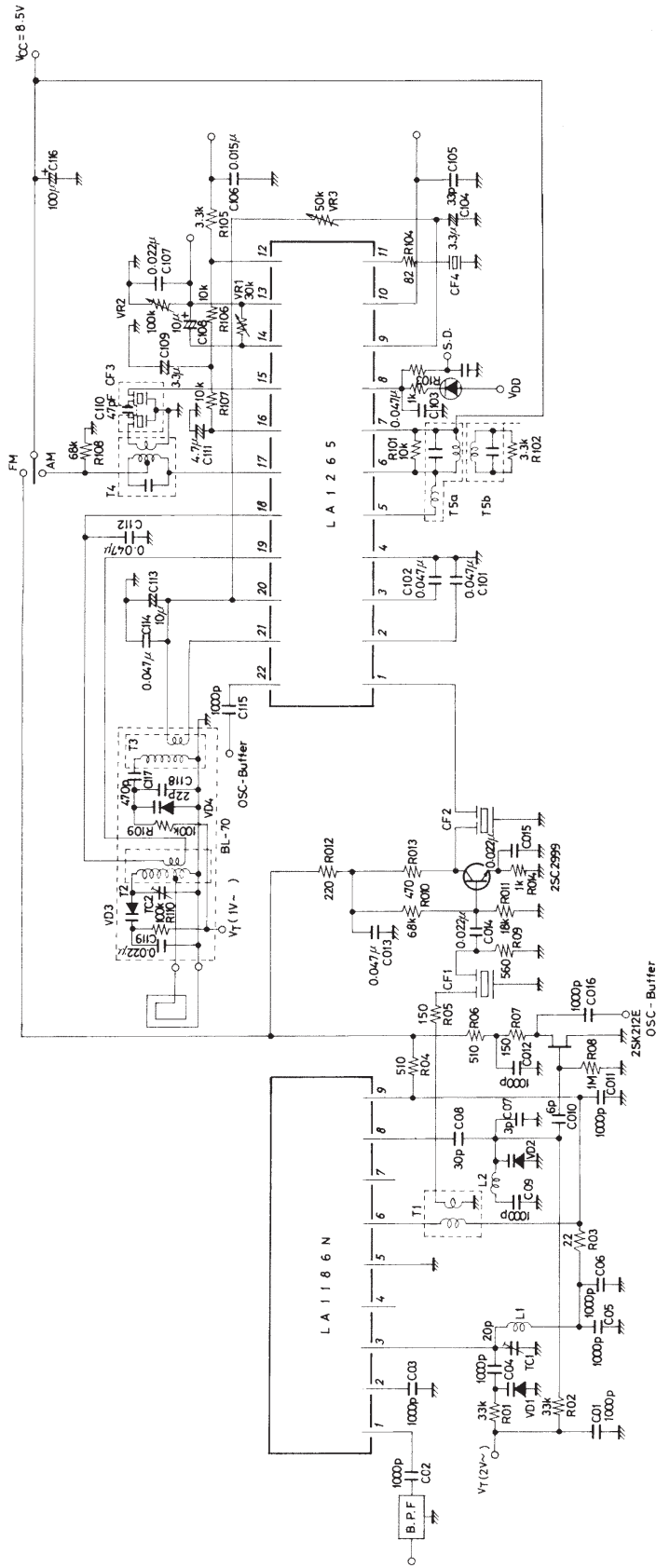

- T1 : YT-30224 (Mitsumi)
- T2 : KL412 (Korin) } BL-70
- T3 : KO387 (Korin)
- T4 : HW-40174 (Mitsumi), 2150-2061-049 (Sumida)
- T5a : HW-40130 (Mitsumi), 2231-096 (Sumida)
- T5b : HW-40130 (Mitsumi), 2231-096 (Sumida)

- B.P. F SNY-2101 (Sumida)
- V_{D1}, V_{D2}=SVC201
- V_{D3}, V_{D4}=SVC321
- TC1=20pF
- TC2=20pF
- CF1, CF2=SFE10.7MA
- CF3=SFZ450B (Murata)
- CF4=BFU450CN (Murata)
- L1 : YT-30196 (Mitsumi), 0708-700 (Sumida)
- L2 : HW50433 (Mitsumi), 0267-034 (Sumida)

Unit (resistance : Ω, capacitance : F)

LA1265

Sample Printed Circuit Pattern (Cu-foiled area)

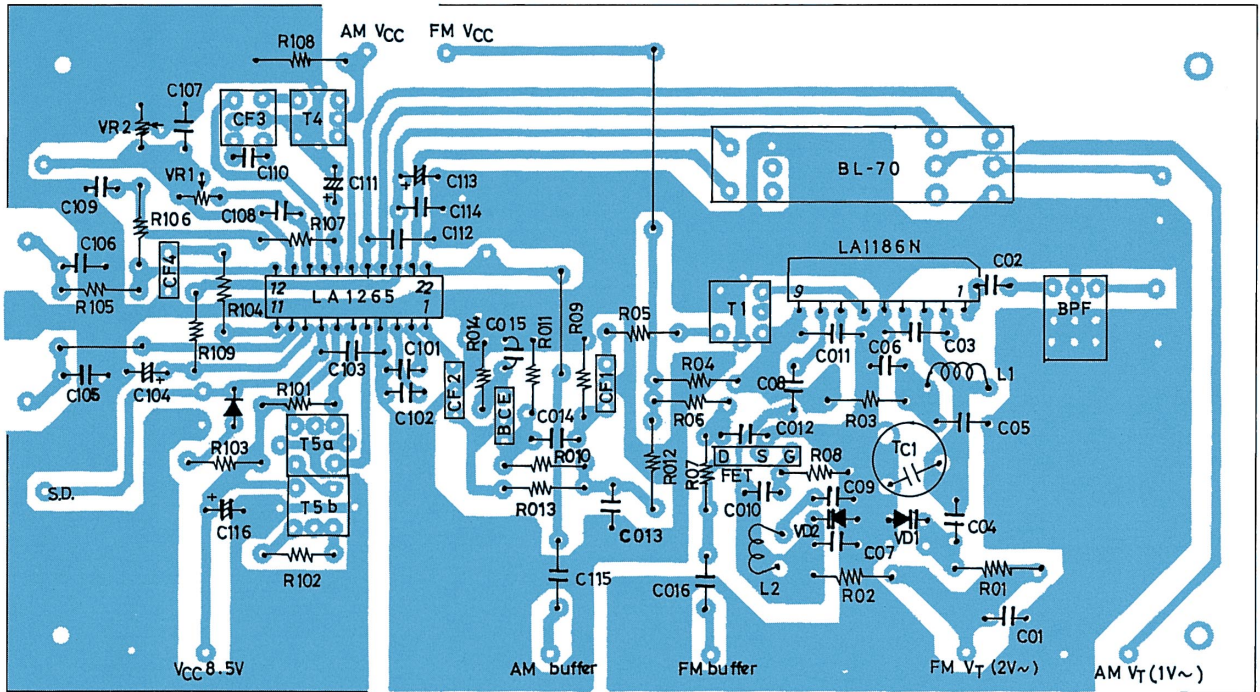

85 × 155 mm²

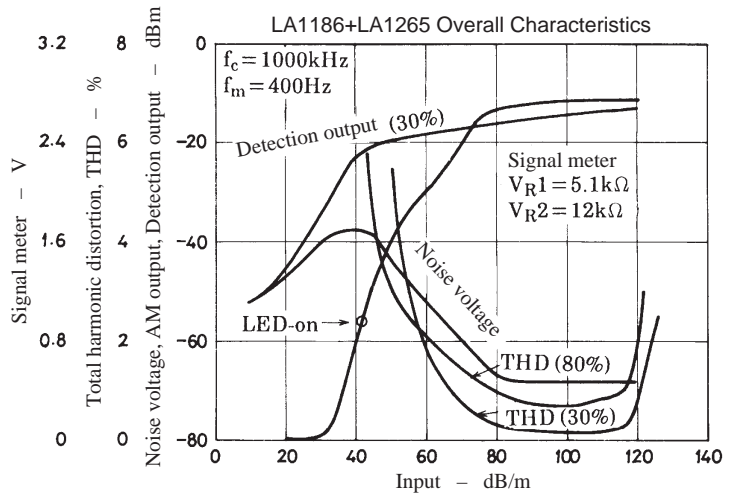
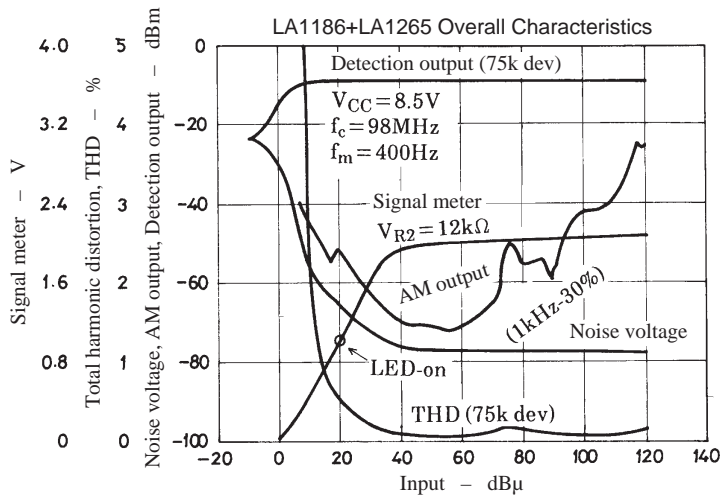

- No products described or contained herein are intended for use in surgical implants, life-support systems, aerospace equipment, nuclear power control systems, vehicles, disaster/crime-prevention equipment and the like, the failure of which may directly or indirectly cause injury, death or property loss.
- Anyone purchasing any products described or contained herein for an above-mentioned use shall:
 - ① Accept full responsibility and indemnify and defend SANYO ELECTRIC CO., LTD., its affiliates, subsidiaries and distributors and all their officers and employees, jointly and severally, against any and all claims and litigation and all damages, cost and expenses associated with such use:
 - ② Not impose any responsibility for any fault or negligence which may be cited in any such claim or litigation on SANYO ELECTRIC CO., LTD., its affiliates, subsidiaries and distributors or any of their officers and employees jointly or severally.
- Information (including circuit diagrams and circuit parameters) herein is for example only; it is not guaranteed for volume production. SANYO believes information herein is accurate and reliable, but no guarantees are made or implied regarding its use or any infringements of intellectual property rights or other rights of third parties.

This catalog provides information as of November, 1997. Specifications and information herein are subject to change without notice.